

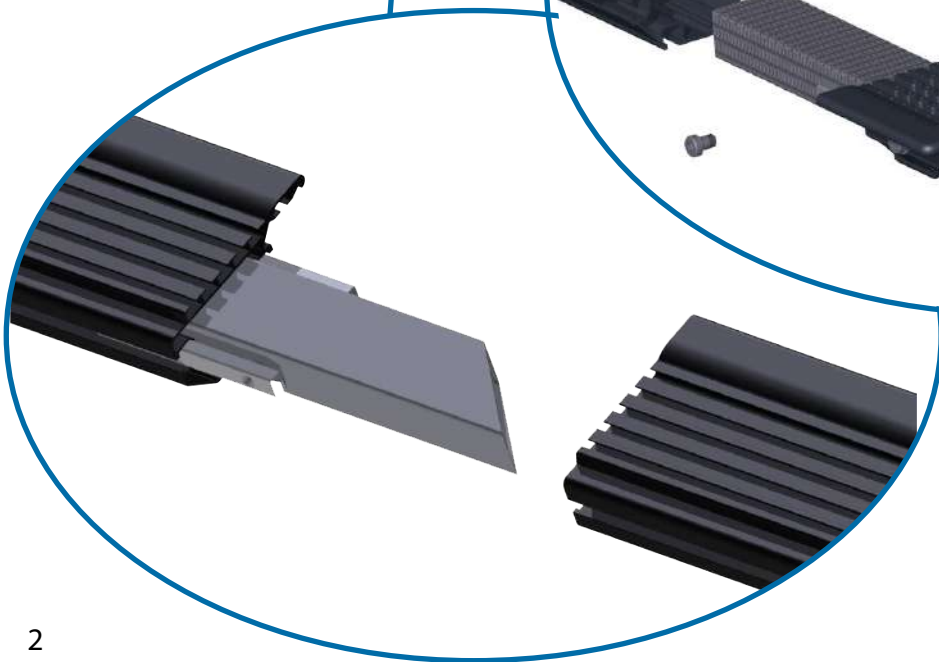

IT

EN

New Only White

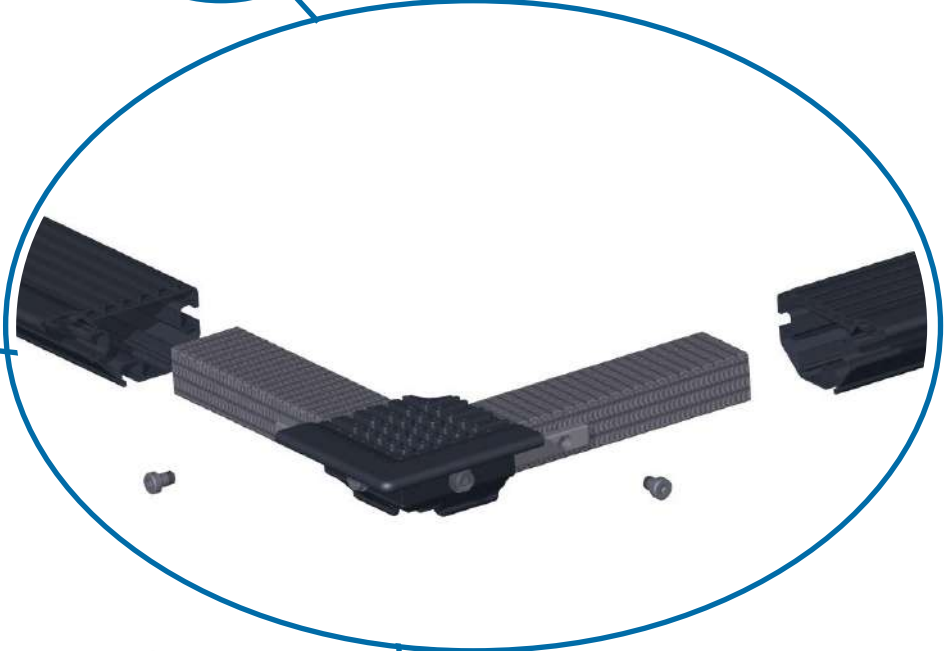
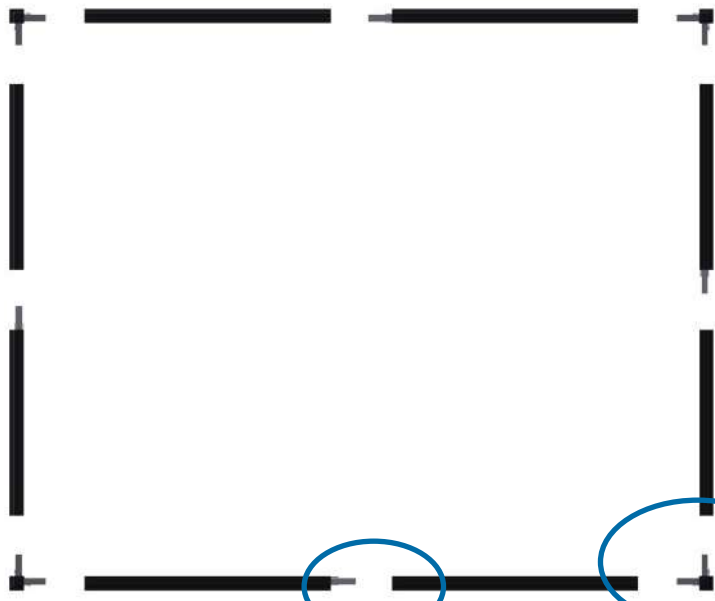
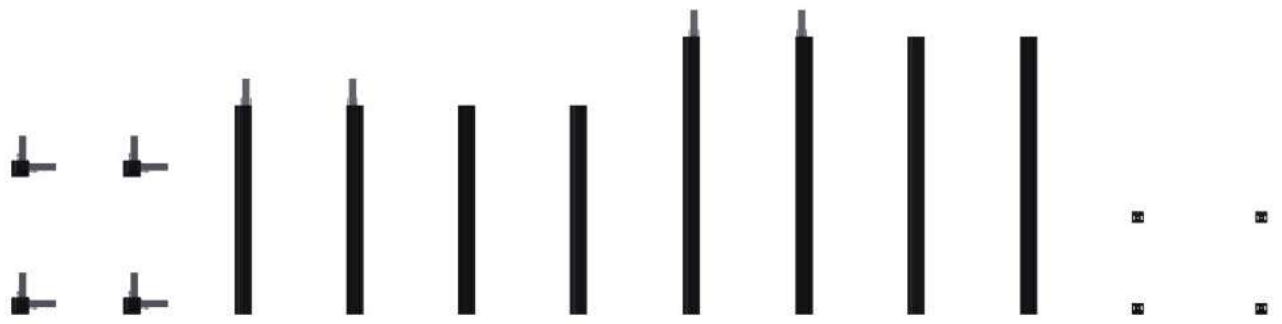

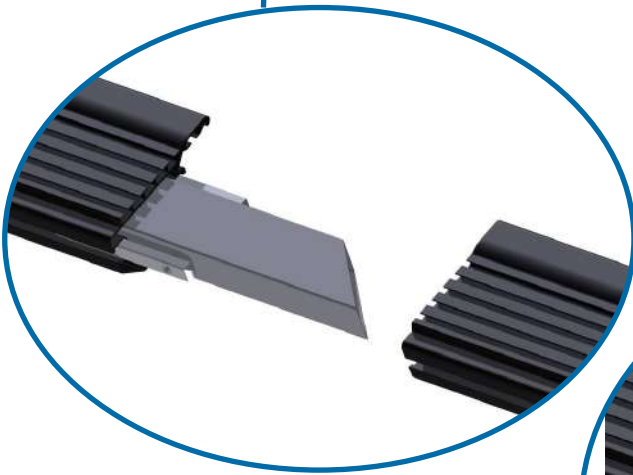
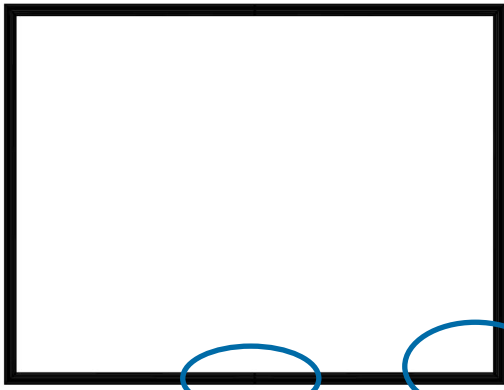

ASSEMBLAGGIO TELA- FABRIC MOUNTING

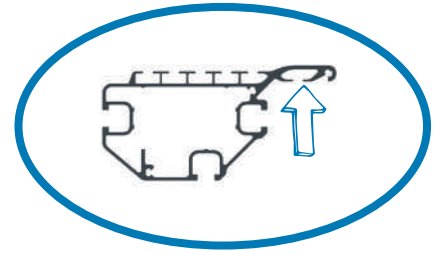

Utilizzare l'apposita cava posta sotto il profilo.
Use the dedicated groove HIDDEN under the profile

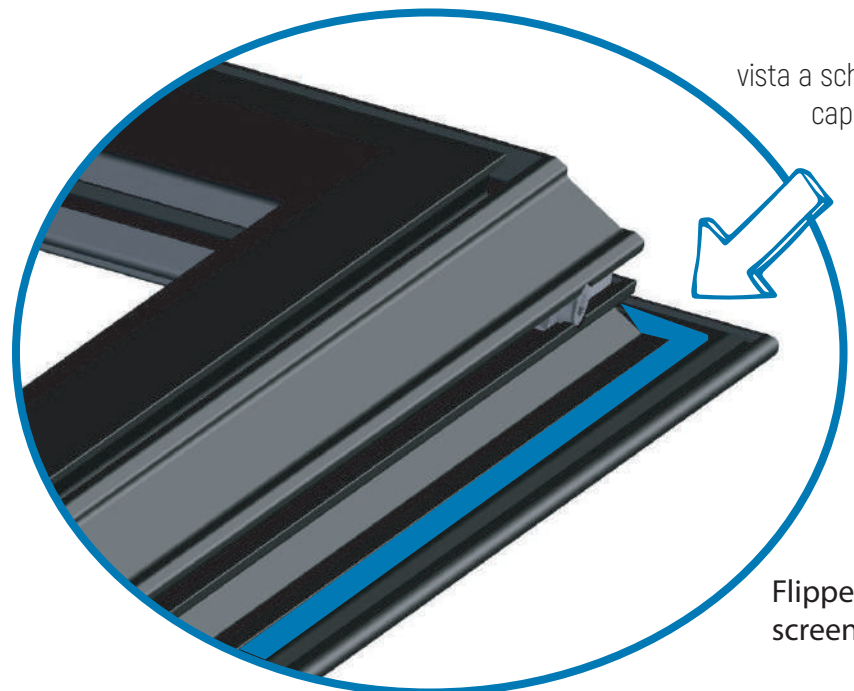
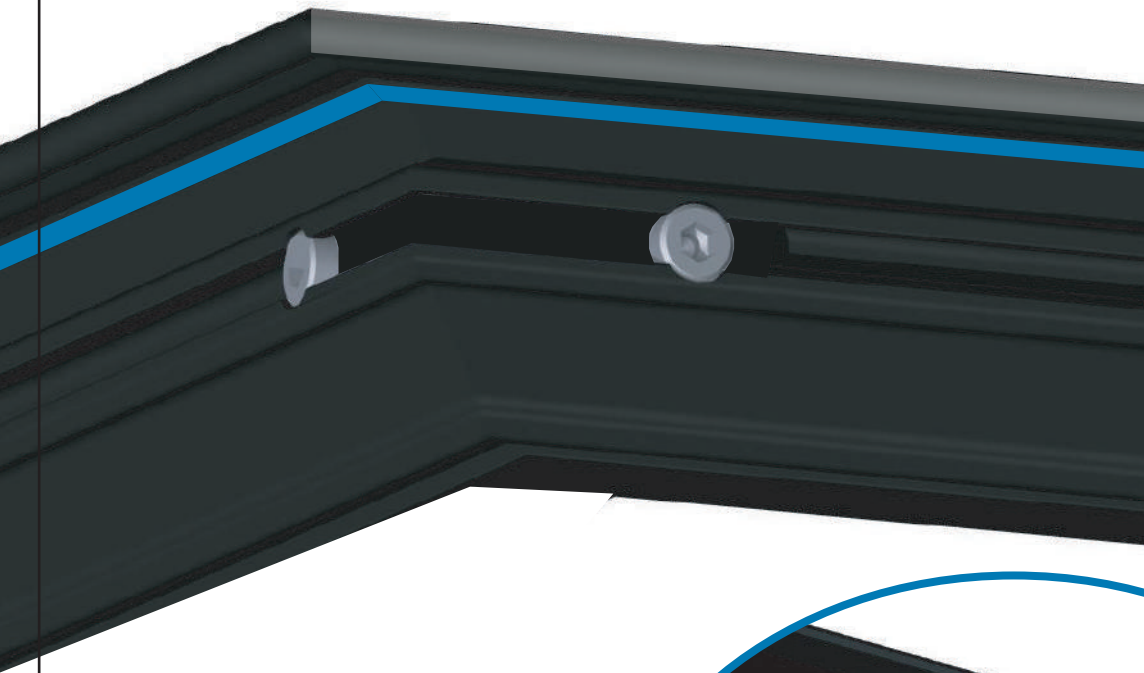

vista a schermo
capovolto

Flipped over
screen view.

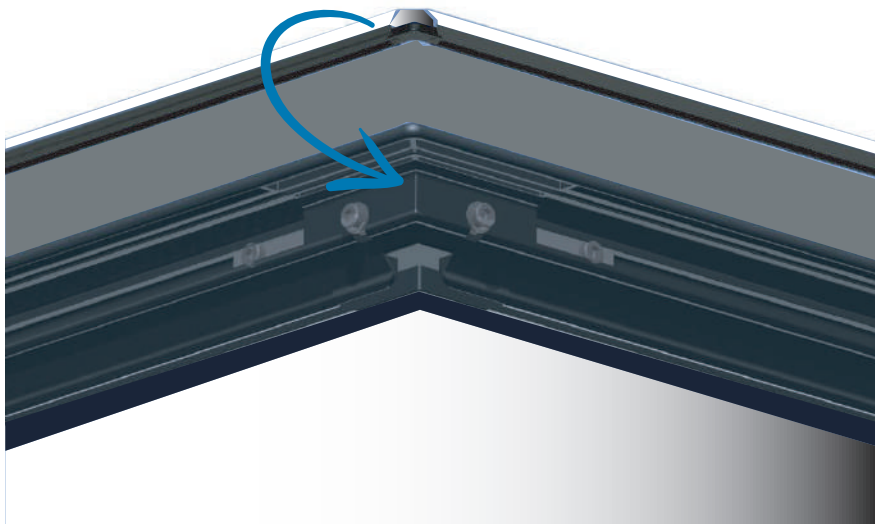

Infilare il bordo della tela nella cava facendo pressione con le mani.
Press in the border of the fabric by hand.



tirare l'angolo come nelle figure per installare la tela nella cava sottostante

pull the corner as showed in the pictures to install the fabric in the rail on the back of the frame.



INSTALLAZIONE STAFFE A PARETE - WALL BRACKETS MOUNTING

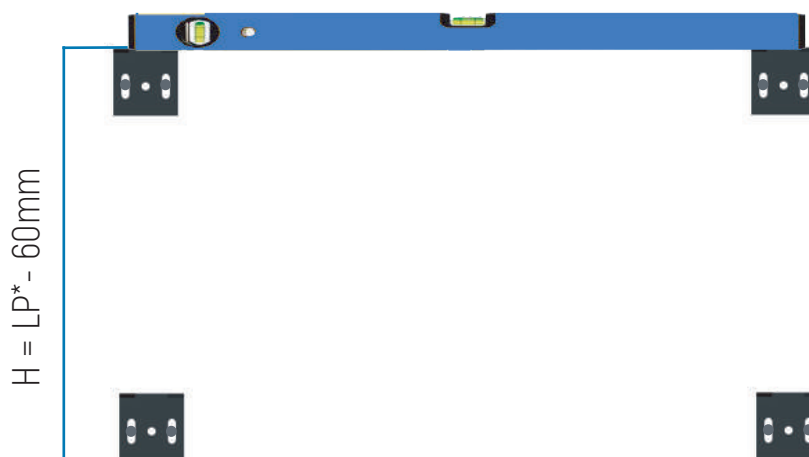
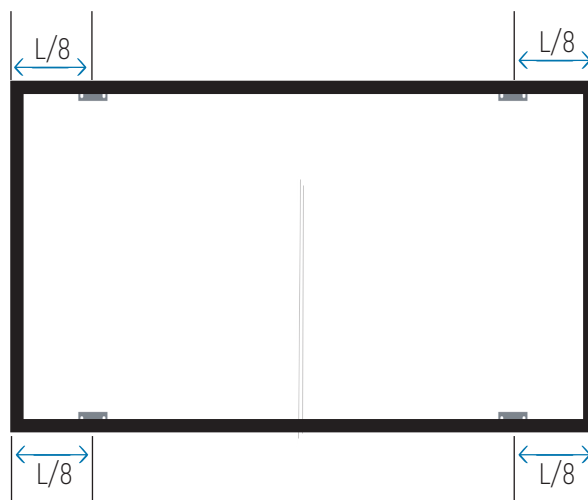

*luce di proiezione - projection light

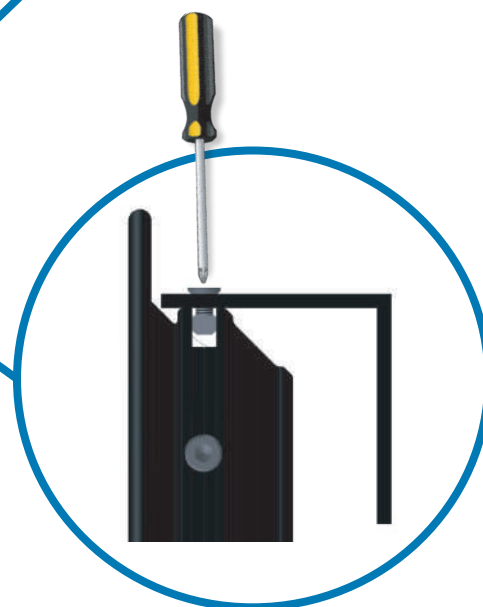
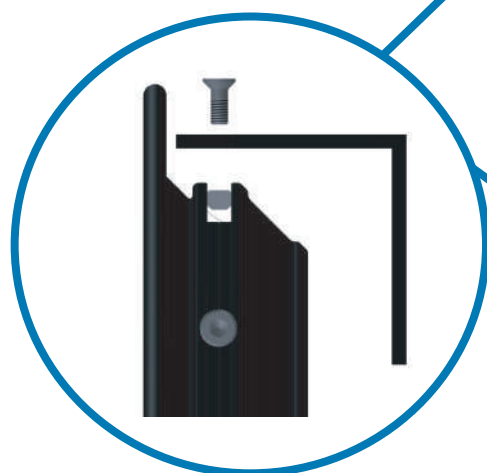
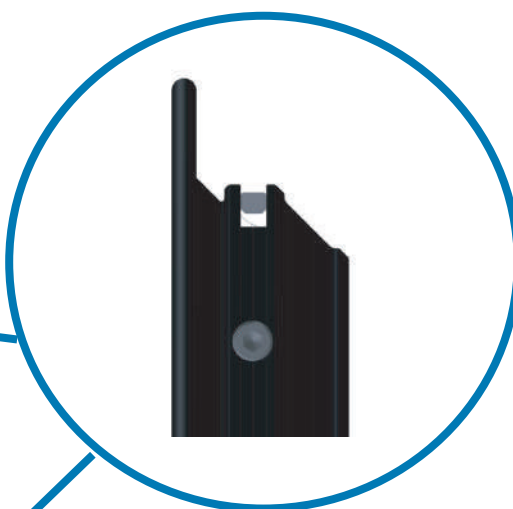
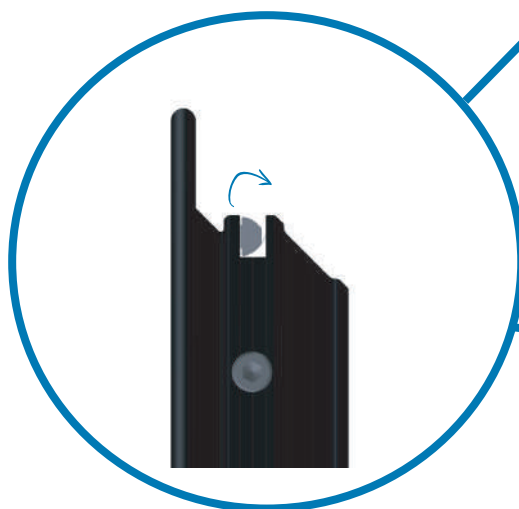
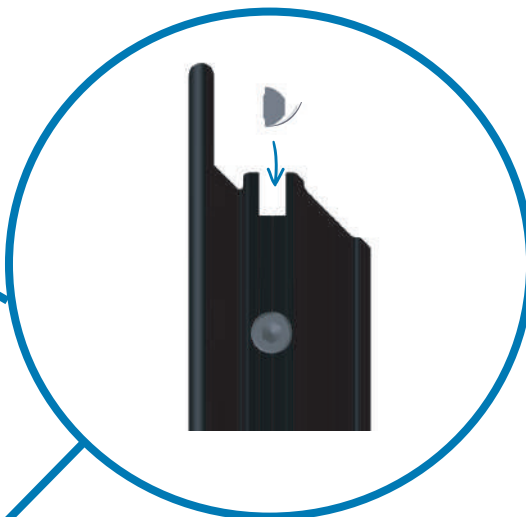
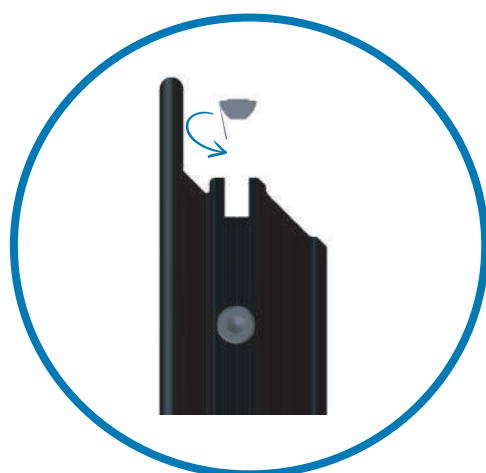
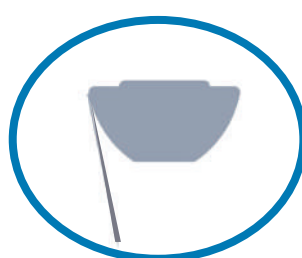

INSTALLAZIONE GOLFARI - EYEBOLTS FASTENING

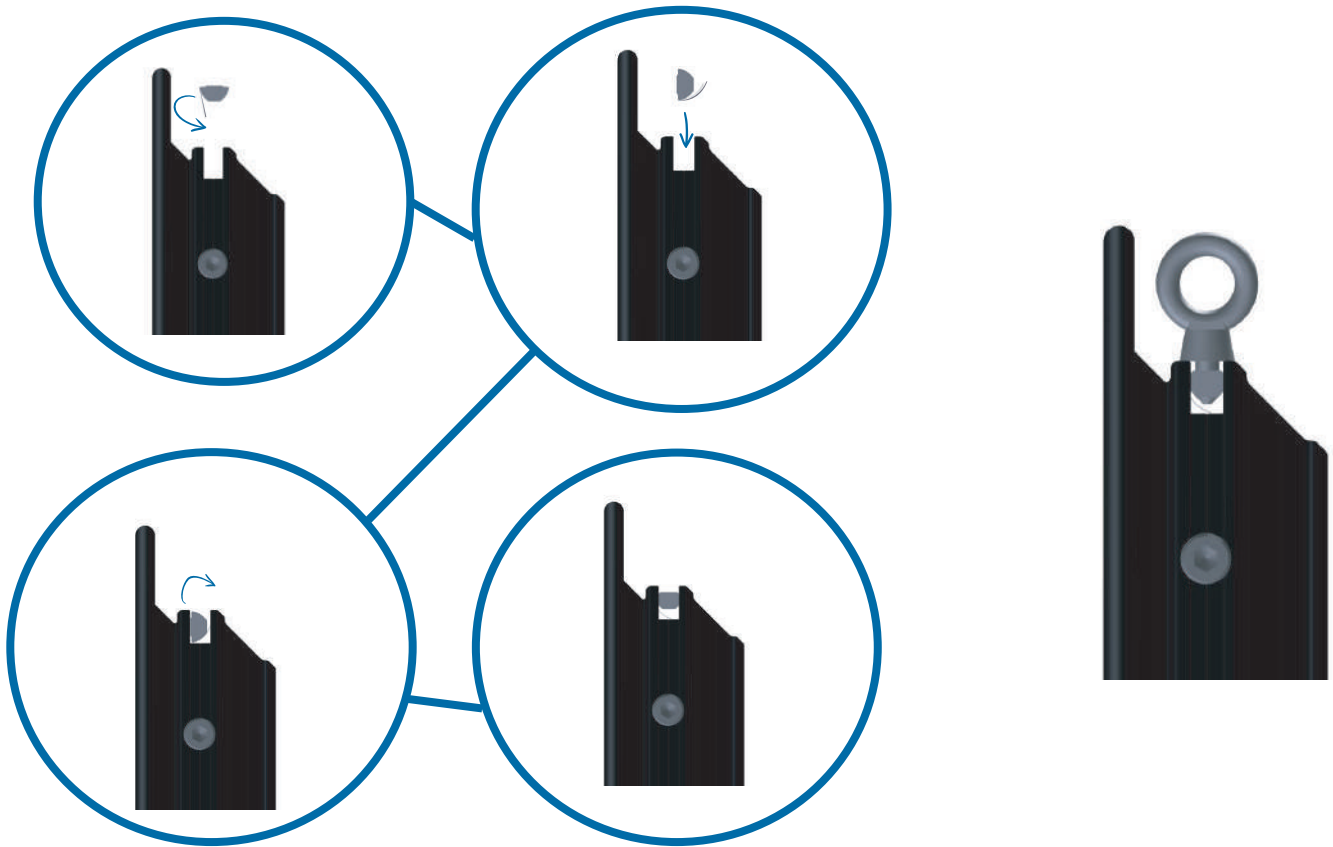

ALISCAF CLAMPS FASTENING

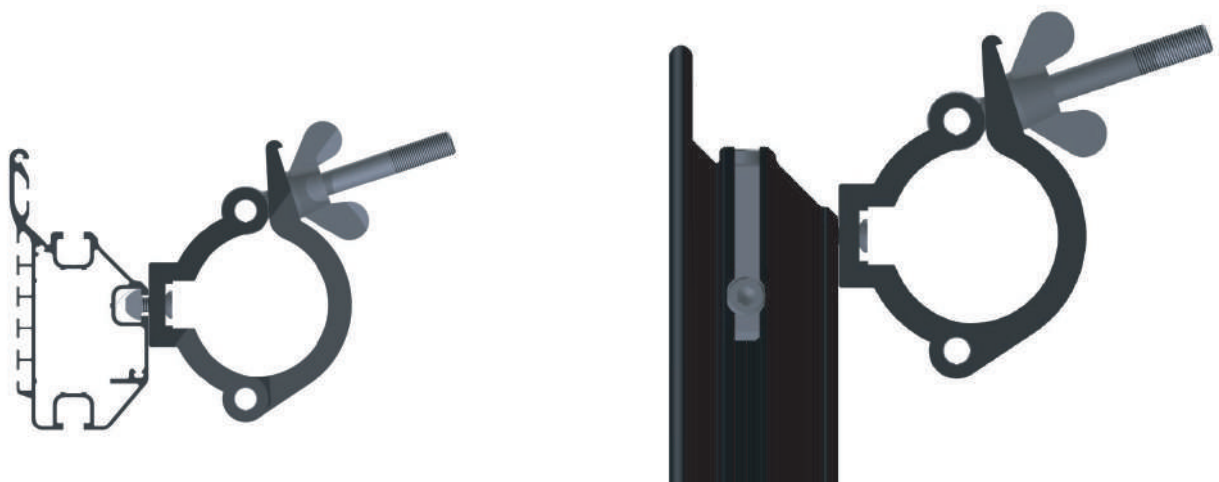

INSTALLAZIONE STATIVI - T-STAND FASTENING

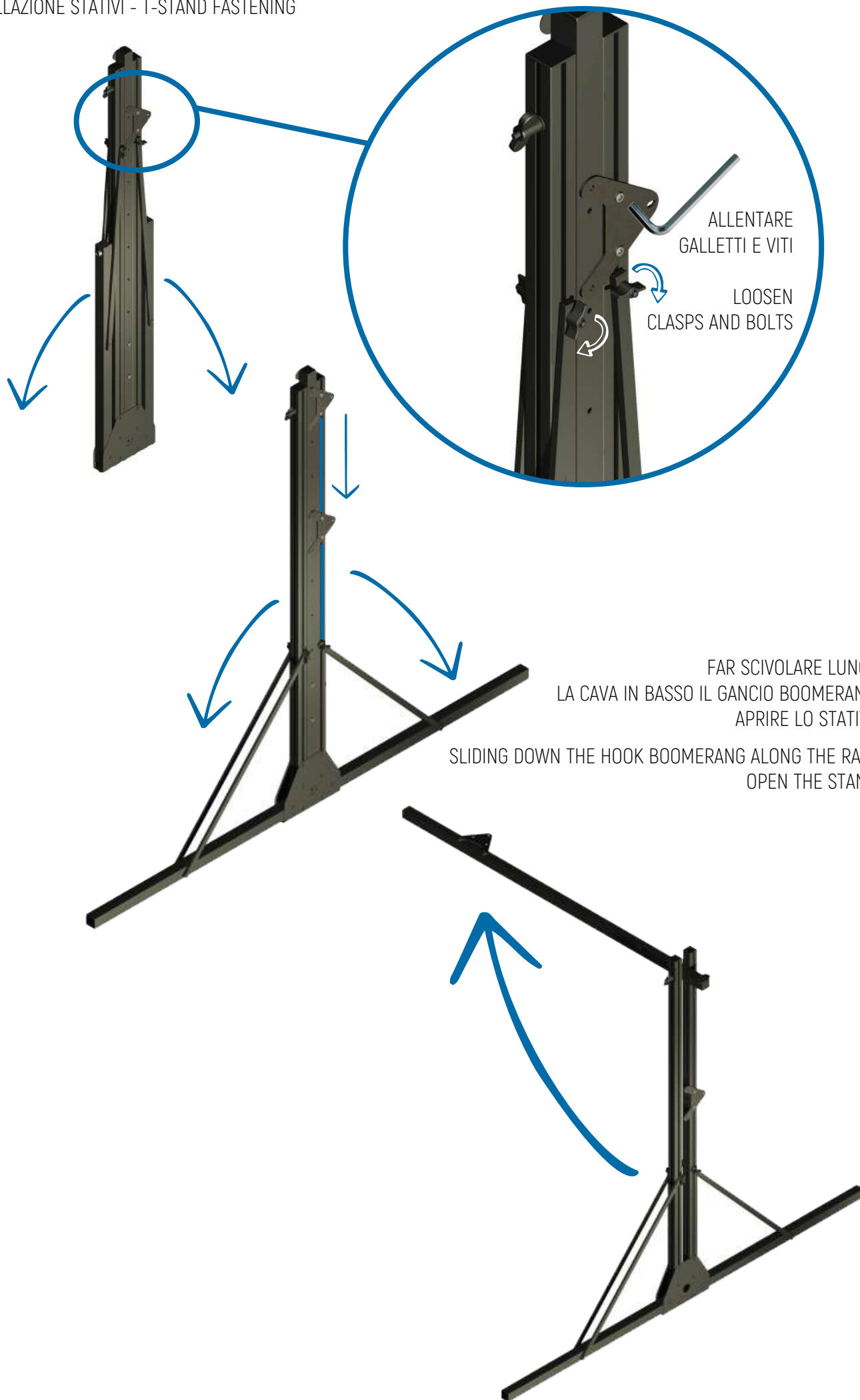

INSTALLAZIONE STATIVI - T-STAND FASTENING

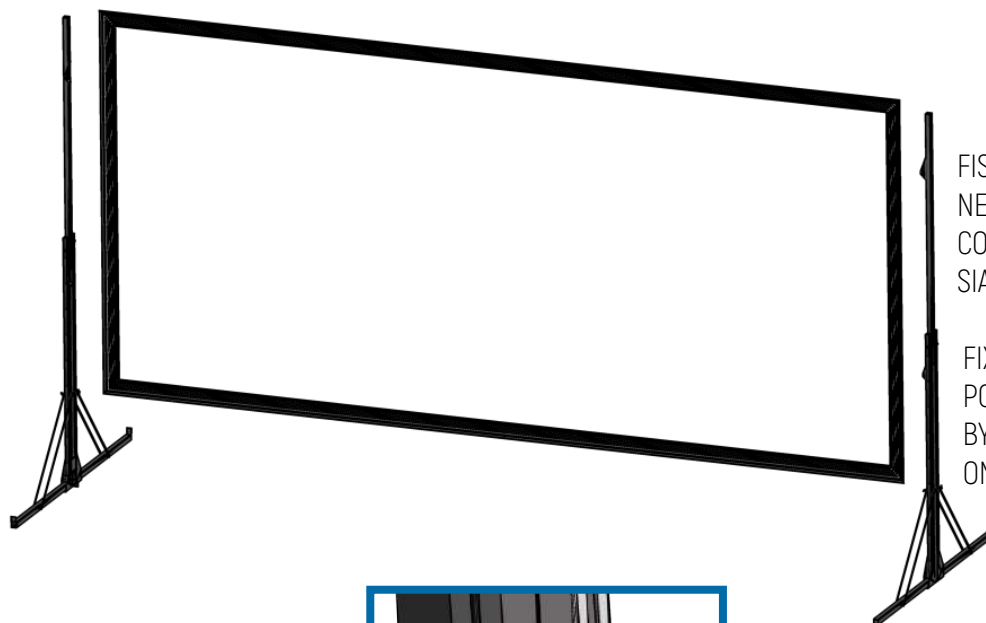

FISSARE I DUE GANCI BOOMERANG NELLA POSIZIONE PIU' ESTREMA CONSENTITA DELLO SCHERMO SIA IN ALTO CHE IN BASSO

FIX HOOKS BOOMERANG IN THE POSITION MORE EXTREME PERMITTED BY THE SCREEN ON THE TOP AND ON THE BOTTOM

SE NECESSARIO SPOSTARE IL GANCIO BOOMERANG NEGLI ALTRI FORI DISPONIBILI

IF NECESSARY MOVE THE HOOK BOOMERANG IN THE OTHER HOLES AVAILABLE

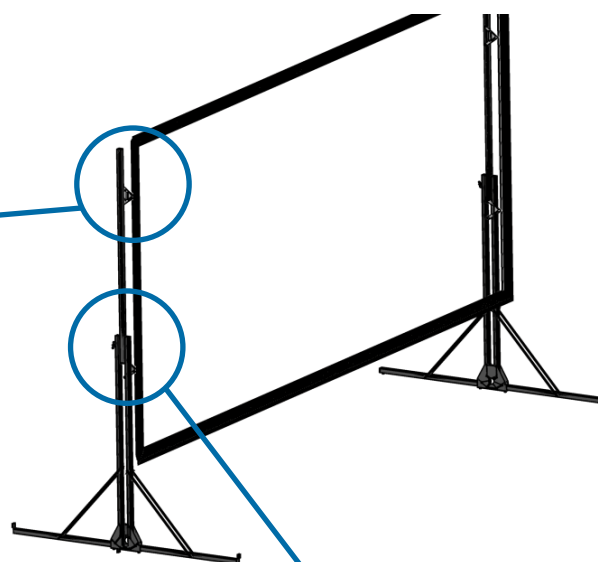
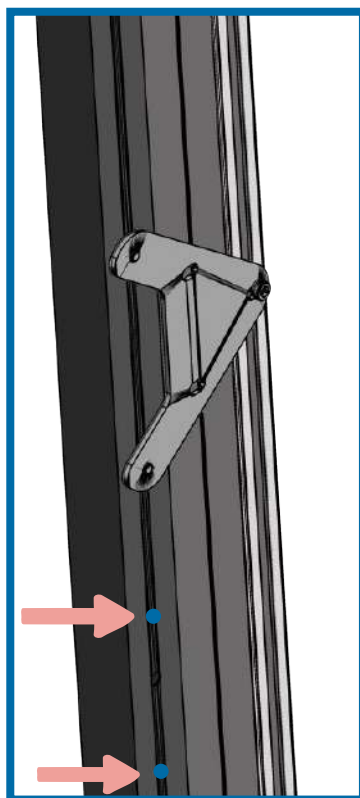

POSIZIONARE IL BOOMERANG NELLA POSSIZIONARE DESIDERATA FACENDOLO SCORRERE LUNGO L'APPOSITO BINARIO.

POSITION THE BOOMERANG IN THE DESIRED POSITION SLIDING IT ALONG THE SPECIFIC RAIL.

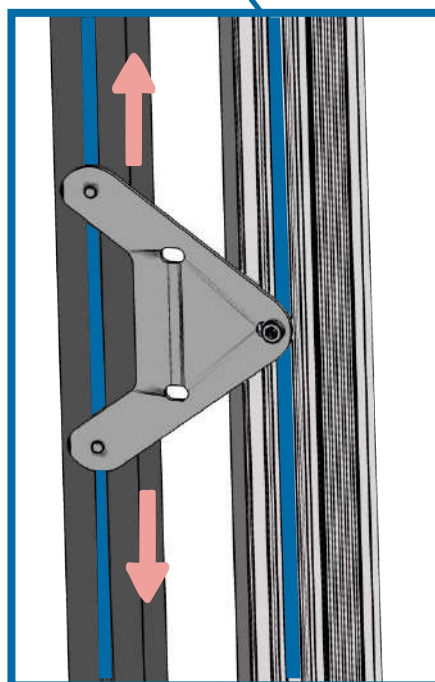

Screenline Srl - Via Nazionale 1/n IT38060 Besenello (TN) Italy
tel +39 0464 830003 - www.screenline.it - info@screenline.it

screenline.it